

**PELLET GRILL AND SMOKER
WARNING & INSTRUCTION BOOKLET
MODEL NUMBER: PPG20**

⚠ WARNING

FOR OUTDOOR USE ONLY

⚠ WARNING

If the information in this manual is not followed exactly, a fire or explosion may result causing property damage, personal injury or loss of life.

⚠ WARNING

- To installer or person assembling this appliance: Leave this manual with this appliance for future reference.
 - To consumer: Keep this manual with this appliance for future reference.
- This instruction manual contains important information necessary for the proper assembly and safe use of this product. Read and follow all warnings and instructions before assembling and using this appliance. Do not discard this instruction manual.

⚠ CAUTION

Use Only Wood Pellet Fuel Specified By The Manufacturer. Do Not Use Pellet Fuel Labeled As Having Additives. Only use Camp Chef Premium Pellets with the following specifications. 8,000-8,300 BTU/LB 0.75-0.85% Ash content

⚠ CAUTION

Contact local building or fire officials about restrictions and installation inspection requirements in your area. **A MAJOR CAUSE OF FIRES IS FAILURE TO MAINTAIN REQUIRED CLEARANCES (AIR SPACES) TO COMBUSTIBLE MATERIALS. IT IS OF UTMOST IMPORTANCE THAT THIS PRODUCT BE INSTALLED ONLY IN ACCORDANCE WITH THESE INSTRUCTIONS.**

⚠ DANGER

1. Never operate this appliance unattended.
2. Never operate this appliance within 10 ft (3 m) of a stored LP cylinder.
3. Never operate this appliance within 25 ft (7.5 m) of any flammable liquid.
4. If a fire should occur, keep away from appliance and immediately call your fire department. Do not attempt to extinguish an oil or grease fire with water.

Failure to follow these instructions could result in fire, explosion or burn hazard, which could cause property damage, personal injury or death.

⚠ CAUTION

Always store wood pellets away from heat producing appliances and other food containers. Pellets should be stored in a dry environment.

⚠ CARBON MONOXIDE WARNING

Follow these guidelines to prevent this colorless, odorless gas from poisoning you, your family or others. Know the symptoms of carbon monoxide poisoning: headache, dizziness, weakness, nausea, vomiting, sleepiness, and confusion. Carbon monoxide reduces the blood's ability to carry oxygen. Low blood oxygen levels can result in loss of consciousness and death. See a doctor if you or others develop cold or flu-like symptoms while cooking or in the vicinity of this appliance. Carbon monoxide poisoning, which can easily be mistaken for a cold or flu, is often detected too late. Alcohol consumption and drug use increase the effects of carbon monoxide poisoning. Carbon monoxide is especially toxic to mother and child during pregnancy, infants, the elderly, smokers and people with blood or circulatory system problems, such as anemia, or heart disease.

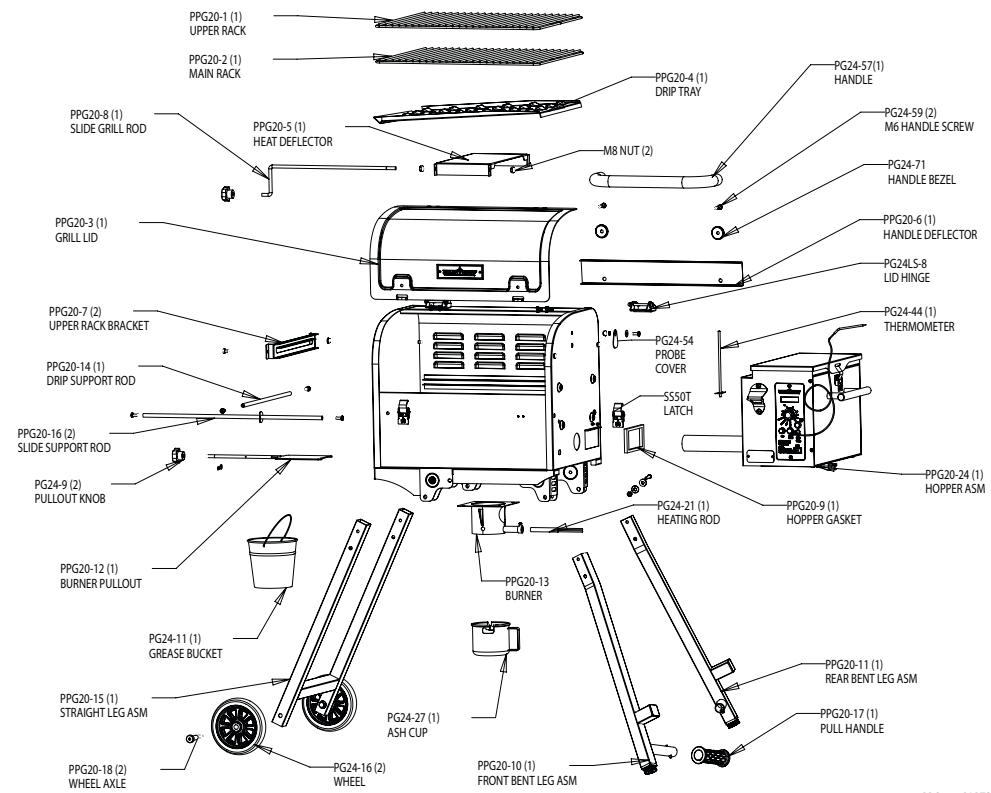

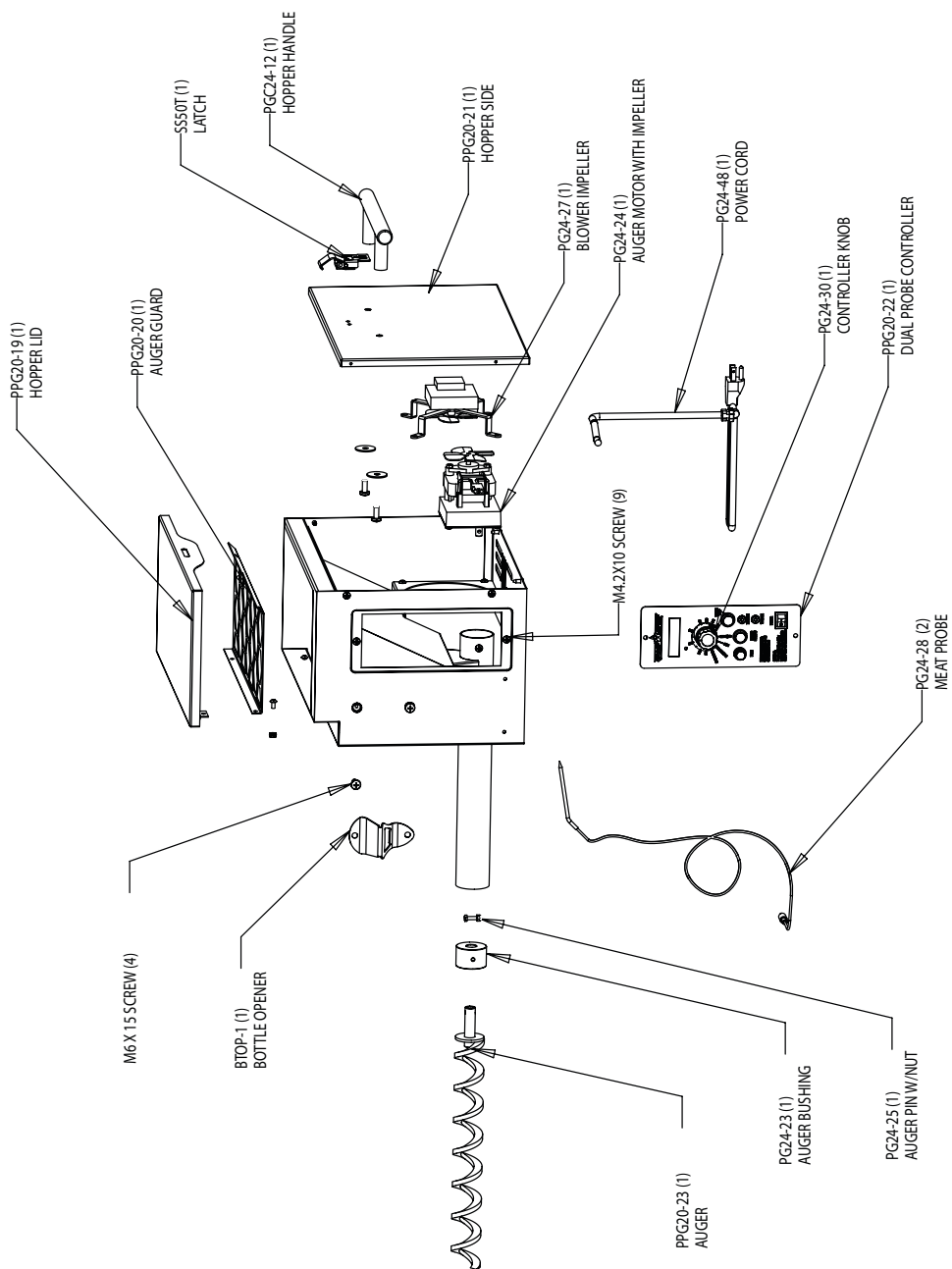

1. Do NOT leave this appliance unattended while in use. The user must remain in the immediate area of the product and have a clear view of the product at all times during operation.
2. Keep children and pets away from burner at all times.
3. The use of alcohol, prescription or non-prescription drugs may impair your ability to properly assemble or safely operate this appliance.
4. For OUTDOOR use only. Do NOT use in a building, garage or any other enclosed area. Do NOT use in or on recreational vehicles or boats. NEVER use this appliance as a heater.
5. Do not operate appliance under ANY overhead construction. Keep a minimum clearance of 36 inches (0.9 m) from the sides, front and back of appliance to ANY construction. Keep the area clear of all combustible material and flammable liquids, including wood, dry plants and grass, brush, paper, and canvas.
6. This product is not intended for commercial use.
7. Always allow the appliance to cool before covering with the patio cover or putting in carry bag.
8. Always cover the appliance, with patio cover (if supplied), when not in use.
9. Always unplug grill before installing patio cover.
10. Use only on a level, stable non-combustible surface like bricks, concrete or dirt. Do not use this appliance on any surface that will burn or melt like wood, asphalt, vinyl or plastic.
11. Make sure burner clean-out is closed before starting the grill.
12. Make sure the grease bucket is in place before starting the grill.
13. In the event of a fire the dial should be turned to shutdown, close the lid, and leave it closed until the fire goes out. After allowing the grill to cool, follow the cleaning instructions before the next use.
14. Use only food grade hardwood pellets manufactured for use in pellet grills. Using softwood or heating pellets will void your warranty.
15. Do not allow the hopper to run out of pellets. Pellets can be added at any time. The hopper will hold approximately 10 pounds of pellets.

The pellet usage will vary greatly depending on the ambient temperature as well as cooking temperature.

16. It is recommended that you not store pellets in the hopper for extended periods as they may absorb moisture from the air and clog the auger.
17. Keep the lid closed during cooking. The grill is designed to cook with the lid closed.
18. Note that the cooking temperature displayed on the digital readout is measured near the cooking surface on the right side of the grill. The actual temperature inside the cooking chamber will vary slightly throughout.
19. Do not use accessories not specified for use with appliance.
20. Never use gasoline, gasoline-type lantern fuel, kerosene, charcoal lighter fluid, or similar liquids to start or freshen up a fire in this appliance. Keep all such liquids well away from the appliance when in use.
21. Ashes should be placed in a metal container with a tight fitting lid. The closed container of ashes should be placed on a non combustible floor or on the ground, well away from all combustible materials, pending final disposal. When the ashes are disposed by burial in soil or otherwise locally dispersed they should be retained in the closed container until all cinders have thoroughly cooled.
22. Creosote – Formation and need for removal. When wood pellets are burned slowly, they produce tar and other organic vapors that combine with expelled moisture to form creosote. The creosote vapors condense in a relatively cool oven flue and exhaust hood of a slow burning fire. As a result, creosote residue accumulates on the flue lining and exhaust hood. When ignited, this creosote makes an extremely hot fire. The grease duct should be inspected at least twice a year to determine when grease and/or creosote build-up has occurred. When grease or creosote has accumulated, it should be removed to reduce risk of fire.
23. Before moving or storing your grill, empty your fire box, remove ash cup and make sure the grill has cooled completely.
24. Do not use the grill with legs folded. Only use with legs fully extended.

⚠ DANGER

Do not work on this grill if it is plugged in. Electric shock may occur resulting in death or serious injury.

HOW TO EXTEND AND FOLD LEGS

1. Place grill upside down on the ground. Press in the push button and slide the pull handle to one side to unfold the legs as shown in Fig 1 and 2.

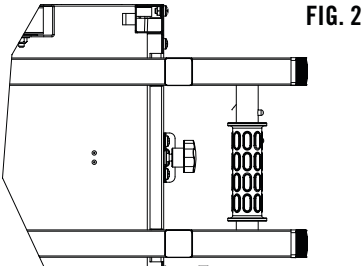
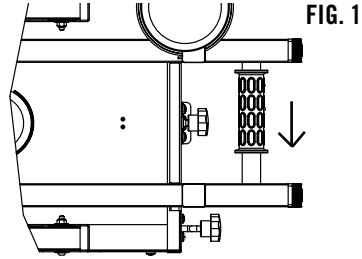

2. Press push buttons in and unfold legs starting with the straight leg with wheels. Make sure all push buttons lock into place as shown in Fig. 3 and 4. Stand grill upright on solid level ground.

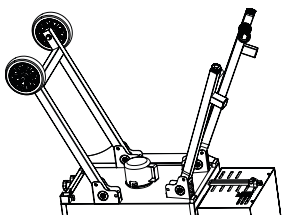
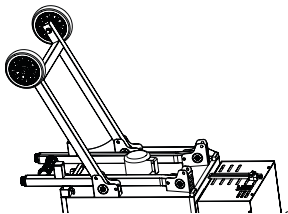

3. Make sure buttons are fully engaged as shown in Fig. 5.

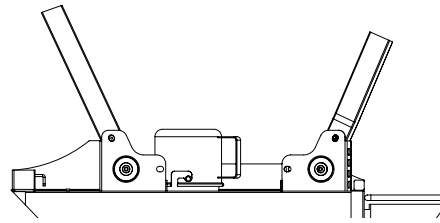

ASSEMBLY INSTRUCTIONS

Remove all loose parts from the inside of the grill and hopper. Lay a blanket or piece of cardboard down to protect the grill.

INSTALL HANDLE

1. Install the handle as shown in Fig 6.
2. Tighten all hardware.

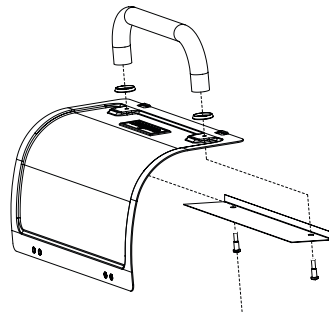

GREASE BUCKET

1. Hang grease bucket from tube as shown in Fig 7.

ASH CUP

1. Install Ash Cup as shown in Fig 7. Never use grill without Ash Cup in place.

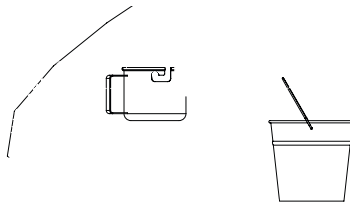

FIG. 7

INSTALL DRIP TRAY

1. Install the Drip Tray as shown in Fig 8 and Fig 9.

FIG. 5

FIG. 6

Drip Tray

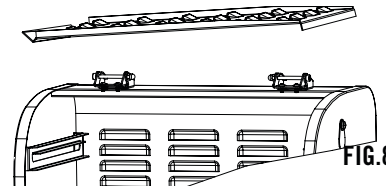

FIG. 9

WARMING RACK AND COOKING GRATE

1. Install the cooking grate as shown in Fig 10.

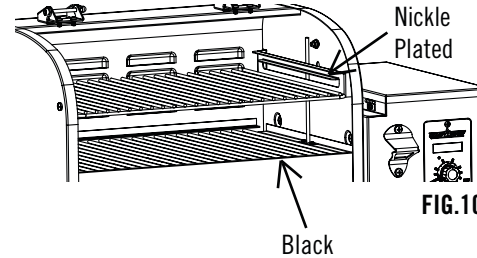

FIG. 10

CLEAN-OUT PORT KNOB

1. Clean-out Port knob must be pushed in when grill is on. Make sure pullout lock is pushed down and locks the knob to prevent inadvertent opening of the clean-out port. See Fig 11.
2. Lift pullout lock and pull clean-out port knob to empty ash into ash cup. See Fig 12.
3. See instructions for burner clean-out.

FIG. 11



FIG. 12



BURNER CLEAN-OUT

Before each use the burner should be cleaned out by lifting the pullout lock and pulling the clean-out port knob on the right side of the grill to open the burner clean-out. This will allow the ash from previous use to fall into the cup under the grill. The cup should be removed and emptied and then reinstalled before each use.

⚠ DANGER

Never Operate the Pellet grill without the ash cup in place. Make sure the burner clean-out port is closed and locked before starting the grill.

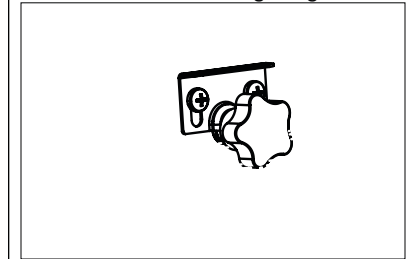

Never open the burner clean-out port when the grill is hot.

After cleaning out the burner make sure to close the burner clean-out by pushing the clean-out port knob in on the left side of the grill. Make sure to lift the pullout lock and push the clean-out port knob all the way in and lock in place with the pullout lock. Every 50 hours of use, remove the grill grates, grease tray, and heat deflector and clean the inside of the grill. If you notice a lot of ash blowing around in the grill it is time to vacuum it out.

FILLING THE AUGER TUBE

CAUTION: ONLY USE THE FEED SETTING WHEN HOPPER HAS RUN OUT OF PELLETS. FEED SETTING IS NOT FOR NORMAL USE.

The first time you use your grill or any time the hopper has ran out of pellets you will need to fill the auger tube. This simply means you must fill the auger tube with pellets until pellets reach the burner. This is done by turning the dial to the FEED position and then holding in the bypass button for 3 seconds. This will turn the auger on and the digital readout will display "FEED". The auger will remain on for no more than 5 minutes. This is ample time for the pellets to reach the burner. It

is easiest to open the burner clean-out by pulling the knob on the left side of the grill. Once you hear pellets dropping into the cup you can close the clean-out port by pushing the knob on the left side of the grill and then select your cooking temperature. (Never operate grill without the ash cup in place). Always make sure the burner clean-out port is closed by pushing in the knob on the left side of the grill before selecting any of the cook settings. Never open the burner clean-out port when the grill is hot.

CONTROLLER EXPLANATION POWER SWITCH

Used to turn the main power onto the pellet grill. If the dial is on Shutdown when the power switch is turned on the digital readout will display “--- --”. The dial must be rotated to any of the other positions before the grill will start. If the power is turned on with the dial in any other position than Shutdown the grill will immediately start that function. “0” is Off. “-” is On. See Fig. 13

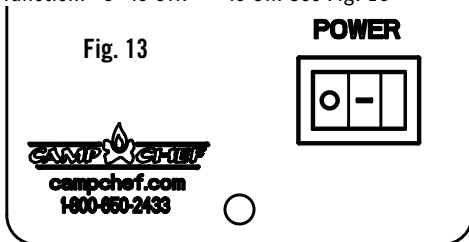

DIAL POSITIONS SHUTDOWN

This setting must be used after each use. Turn the dial to this setting and the fan will remain on for 20 minutes before turning off. This setting will burn up any extra pellets in the burner and cool down the grill. Do not turn the main power switch off when the grill is hot.

FEED - This setting is used to feed pellets to the burner. It will be used the first time you use the grill to fill the auger tube and any time you may inadvertently run the hopper out of pellets. See instructions on filling the auger tube.

LOW SMOKE - This setting is used for smoking foods at an average temperature of 160F. This setting will produce large amounts of smoke.

HIGH SMOKE - This setting is used for smoking foods at an average temperature of 220F. This setting will produce large amounts of smoke.

175F TO 400F - There are 25F increment settings

from 175F to 400F. You can simply select any temperature you want and the grill will control the temperature within 15F of the selected temperature.

HIGH - This setting can be used to achieve temperatures up to 500F depending on ambient temperatures.

DISPLAY

“START” - The digital readout will display “START” each time the dial is changed from the OFF, SHUTDOWN, or FEED settings to any of the cook settings. The startup cycle is approximately 8 minutes. During the cook cycle after the start sequence the digital readout will display the temperature inside of the grill. If the Probe Temp button has been pressed then it will display the temperature of the external probe used for measuring meat temperatures.

“SDOWN” - The digital readout will display “SDOWN” when the dial is turned to the shutdown mode. After 20 minutes the digital readout and the fan will turn off.

“SENSR” - The digital readout will display “SENSR” if there is an error with the temperature sensor inside of the grill.

“PRERR” - The digital readout will display “PRERR” when the Probe Temp button is pressed if either the external probe is not plugged in or there is a problem with the probe.

“FEED” - The digital readout will display “FEED” if dial is turned to the feed mode. After 5 minutes the auger will turn off.

“BPASS” - The digital readout will display “BPASS” when the bypass button is pressed and held in for 3 seconds. See the setting on Bypass Mode.

“FLAME” - The digital readout will display “FLAME” if the fire is extinguished.

“OVRTMP” - The digital readout will display “OVRTMP” if the grill reaches over 600 degrees F.

BREAKING IN THE GRILL

We suggest turning the grill to 350F for ½ hour before cooking on the grill for the first time. This will burn off any manufacturing oils and cure the paint. Make sure to follow the instructions for filling the auger tube before breaking in the grill.

⚠ WARNING

Always start the grill with the lid open. The lid must be closed after the start cycle.

COOKING

Once the auger tube has been properly filled you can begin cooking by selecting any of the cooking temperatures. The grill has 13 cook settings. Low Smoke, High Smoke, 175, 200, 225, 250, 275, 300, 325, 350, 375, 400, and High. By selecting any of these the grill will go into the Startup mode. The digital readout will display “START” for 8 minutes during the startup cycle. After the 8 minutes the digital readout will display the internal temperature of the grill. The dial can be changed at any time during the startup cycle or the cook cycle between any of the 13 cook settings.

⚠ WARNING

Do not over-fire the grill by over feeding pellets into the burner prior to startup. If flame is inadvertently extinguished never restart the grill without first cleaning out the burner. Improper use can cause an uncontrolled fire.

DIRECT FLAME MODE

Pull grill knob out all the way to allow direct heat as shown in Fig 14. Best for burgers and steaks.

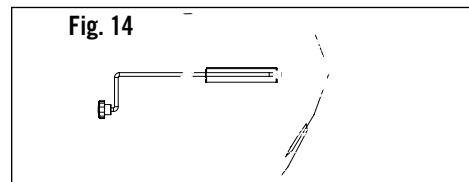

⚠ WARNING

Always clean grease tray to remove excess grease drippings prior to cooking in Direct Flame Mode. A dirty grease tray may result in excessive flare ups or grease fire. If grease fire does occur, turn off grill using the main power switch and close the lid. Leave the lid closed until fire is extinguished. If an uncontrollable fire does occur, immediately call local fire department. Never put water on the fire.

INDIRECT FLAME MODE

Push grill knob in all the way for indirect heat as shown in Fig 15. Best for chicken, slow smoking and low temps.

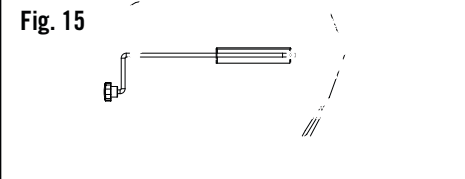

SHUTDOWN

When you are done cooking the dial must be turned to the Shutdown setting. The digital readout will display “SDOWN”. In this setting the fan will remain on for 20 minutes to finish burning any pellets in the burner and cool the grill down. After 20 minutes the digital readout and fan will turn off. At this point the main power switch should be switched to off. Before grill can be used, the power switch must be turned off and back on.

Note: During shutdown the grill will continue to feed pellets periodically through the shutdown cycle.

BYPASS MODE

The bypass may be used if there is a power failure, or the grill is accidentally turned off, or anytime you need to restart the grill and it is still hot.

The bypass mode should only be used if the grill has been off less than 3-4 minutes. This method is used to bypass the normal startup mode and get the grill cooking again quickly. The burner must still be hot enough to ignite new pellets or this method will not work. In order to initiate the bypass mode you must first select the cook setting you want. At this point the digital readout will display “START”. Simply press the bypass button in and hold it for 3 seconds. The digital readout will display “BPASS”. Release the button and the grill will go into the cook mode and the digital readout will display the grill temperature. If the grill fails to ignite using the bypass mode then restart the grill using the normal startup procedures.

Meat Probes

This smoker has built in meat probes to measure the temperature of the food as it is being cooked. To use these probes insert the wire through the stainless flaps on the side of the firebox. Insert the probes into the food. Plug the connectors into the receptacles on the front of the control panel. When you press the probe temp button on the front of the controller the digital readout will display the food temperature. Press the button a second time to toggle the display to the other probe. Press the button a third time to toggle back to the cooking

temperature. If the probes are not installed correctly or there is an error with the probes the digital readout will display “PRERR” when the probe temp button is pressed. When running the probe wires to the food make sure it is positioned out of direct contact with any open flame or damage may occur. The digital readout will display a “X” in front of the number when displaying the “X” meat probe temperature and a “Y” for the “Y” meat probe temperature. Example: “X155F”

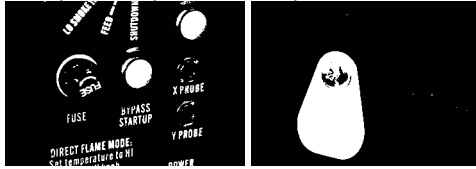

CAUTION

Do not use meat probes when grill temperature exceeds 350°F. Damage to the probes may occur. Do not allow meat probe wires to lie in the direct heat zones (as shown by shaded areas).

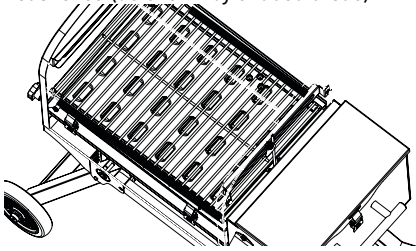

Direct heat will damage the meat probe wires. Always route the meat probes through ports on the side of the grill. Do not submerge wire in water. Not dishwasher safe.

CLEANING

Clean grates using a wire grill brush. This should be done with each use. DO NOT use oven cleaner or abrasive cleaners on the painted grill surfaces. Use warm soapy water on all painted surfaces. Clean grease pan and grease drain tube occasionally. A spatula can be used to scrape excess grease and a grill brush to brush clean. Do not allow grease to build up on the grease tray or in the grease drain as this can cause flare-ups inside the grill. Make sure not to obstruct the flow of grease off of the tray and into the grease drain. Make sure not to block the airflow to the temperature sensor on the right side of the grill.

TROUBLESHOOTING

GRILL DOES NOT TURN ON.

Grill fails to turn on after switching the power button to the on position.

1. Make sure the grill is plugged into a powered outlet. Check the circuit breaker and/or GFCI switch. Test the outlet using another appliance.
2. Unplug the grill and check the fuse located in the front panel. If the fuse is blown replace only with 4.0 Amp 125V 5x20mm Fast Blow Fuse. Typical fuse marking will be 4A125V, F4A125V, 4A250V, or F4A250V. Make sure to confirm they are a Fast Blow Fuse. Actual fuse dimensions are 5.2x20mm.

If problem cannot be resolved please call customer service.

GRILL DOES NOT HEAT UP OR DIGITAL READOUT DISPLAYS FLAME

1. Turn Power Off
2. Check hopper for pellets
3. Check firebox to see if there are pellets in the firebox. The easiest way to do this is to pull the burner clean-out lever. Then remove the cup from the bottom of the grill and check for pellets. Use a vacuum to clean-out any pellets that may be in the bottom of the grill.
 - A. If there are a lot of pellets in the cup. Reinstall the cup and close the burner clean-out, remove the grill grates, grease tray, and heat deflector and vacuum out any pellets in the bottom of the grill. Try restarting the grill. If restarting the grill does not work and pellets are getting to the burner cup the heating rod may need to be replaced.
 - B. If there are few or no pellets in the cup then turn the dial to the feed position and see if pellets fall out the bottom of the burner. If there are no pellets check to see if the auger is turning. If the auger motor is turning but the auger is not there may be a sheared auger pin. You can determine if the auger motor is turning by watching the small white fan at the end of the auger motor under the hopper. If the white fan is turning the auger motor is on. If the white fan is turning and the auger is not you will need to replace the auger pin.

If problem cannot be resolved please call customer service.

DIGITAL READOUT DISPLAYS SENSR

1. Turn the power off and unplug the grill.
2. Check to make sure the sensor inside of the grill

is connected properly to the electronic board under the hopper.

3. Call customer service for a replacement sensor.

DIGITAL READOUT DISPLAYS PRERR

1. Press the Probe Temp button - Pressing the Probe Temp button will toggle the digital readout between the actual temperature inside of the grill and the temperature measured using the meat thermometer.
2. Make sure the meat thermometer is connected properly to the front of the grill. If the Probe Temp button is pressed to display the Probe Temp without the meat thermometer properly connected to the front of the grill it will display PRERR.
3. Call customer service for a replacement meat thermometer.

DIGITAL READOUT DISPLAYS “-----”

1. Rotate the dial from Shutdown to feed or any other cook setting.

DIGITAL READOUT DISPLAYS OVRTMP

1. Turn power off.
2. Let the grill cool down completely.
3. Pull the clean-out lever to remove any pellets/ash from the firebox. Then remove the cup from the bottom of the grill and dispose of pellets/ash.
4. Reinstall ash cup under the grill. Close the burner clean-out, remove the grill grates, grease tray and slide the heat diverter plate to the side and vacuum out any pellets/ash from the bottom of the grill.
- 5 Clean all grease drippings from the grill.
6. Replace all components.
7. Restart the grill.

STORING THE PURSUIT GRILL

1. Remove the ash and grease cups from the pellet grill.
2. Store the ash cup in the grease cup and place both between the top and bottom grill grates as shown in Fig. 16.

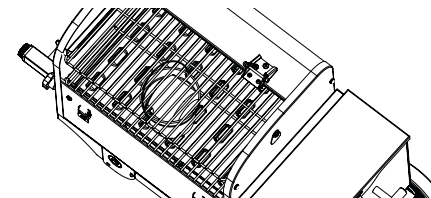

3. Use the latches to secure the lids so they do not open.
4. Put the grill on its back and fold in the legs as shown in Fig. 17, 18 and 19.
5. Make sure all of the push buttons latch correctly as shown in Fig. 20

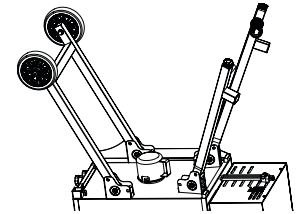

FIG. 17

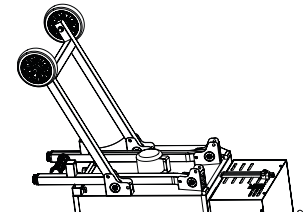

FIG. 18

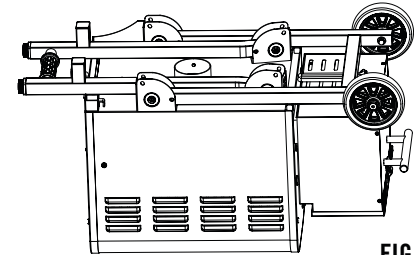

FIG. 19

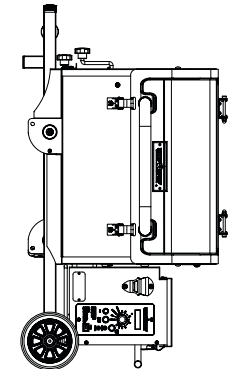

FIG. 20

CAUTION

This device complies with Part 15 of the FCC rules. Operation is subject to the following two conditions: 1 this device may not cause harmful interference, and 2 this device must accept any interference received, including interference that may cause undesired operation.

Note: This equipment has been tested and found to comply with the limits for a Class B digital device, pursuant to part 15 of the FCC Rules.

These limits are designed to provide reasonable protection against harmful interference in a residential installation. This equipment generates, uses and can radiate radio frequency energy and, if not installed and used in accordance with the instructions, may cause harmful interference to radio communications. However, there is no guarantee that interference will not occur in a particular installation. If this equipment does cause harmful interference to radio or television reception, which can be determined by turning the equipment off and on, the user is encouraged to try to correct the interference by one or more of the following measures:

- Reorient or relocate the receiving antenna.
- Increase the separation between the equipment and receiver.
- Connect the equipment into an outlet on a circuit different from that to which the receiver is connected.
- Consult the dealer or an experienced radio/TV technician for help.

LIMITED WARRANTY

Camp Chef No-Hassle Warranty

Here at Camp Chef we stand by our products and take pride in our customer service. Because of this, your new Camp Chef product comes with a No-Hassle Warranty. What does that mean? It means that if we did something wrong, we will make it right. We guarantee our products to be free from defect in all materials and workmanship (excluding paint and finish). We will replace defective parts so you can get back to enjoying your product as soon as possible.

Required Maintenance:

Clean your product after each use to maintain its finish and prolong its lifespan. Wipe away all grease and ashes. Keep metal products free of moisture, salts, acids and harsh fluctuations in temperature. Unfortunately, product paint and other finishes are not covered by this warranty. The exterior finish of the product will wear down over time.

Coverage Details:

Warranty does not cover normal wear of parts or damage caused by misuse, abuse, overheating and alteration. No alterations are covered in this warranty. Camp Chef is not responsible for any loss due to neglectful operation. Furthermore, this warranty does not cover items purchased from a 3rd party company, unauthorized dealers, or damages caused by natural disasters such as earthquakes, hurricanes, tornadoes, floods, lightning, fires, etc.

Upon the expiration of this warranty, all such liability will terminate. No other warranties are expressed or implied.

Please keep all original sales receipts from the authorized dealer. Proof of purchase is required to obtain warranty services. Any parts or products returned without written authorization will be discarded without notice.

To obtain warranty services submit a warranty request at <http://www.campchef.com/warranty-information>, email warranty@campchef.com, or call 1.800.650.2433. Our Product Specialists are happy to help.

Warranty applies to the contiguous U.S. states only.

WARRANTY COVERAGE PERIODS

Pellet Grills	3 year from purchase date
Stoves	1 year from purchase date
Fire Pits	1 year from purchase date
Water Heaters	1 year from purchase date
Movie Screens	1 year from purchase date
All other items & accessories	90 days from purchase date

